



USER MANUAL

Changsha KILOVIEW Electronics CO., LTD.

Legal Notices

Subject to the receiving of this document from Changsha Kiloview Electronics Co., Ltd.,(Hereinafter referred to “Kiloview”), the following terms are understood and agreed. Or else, please stop using this document.

This document is copyright of Kiloview, all rights reserved. The document covers the proprietary information of the company. No company or individual may copy, transmit, distribute, use or disclose the document and any images, forms, data and other information contained in the document without the prior written permission of the company.

 *is the registered trademark of Kiloview. The name and logo are the trademarks or registered trademarks of the company. Other products or company names mentioned in this document may be the trademarks or registered trademarks of their respective owners. The reading of this document without the prior written consent of the company or the third party rights holder does not imply that the reader is given any right to use any of the marks appearing in this document by implication, non-evidence or otherwise.*

This product complies with the design requirements related to environmental protection and personal safety. The storage, usage and disposal of the product shall be in accordance with the product manual, relevant contract or relevant national laws and regulations.

This document is provided "as is" and "only in this state". Products and technical updates are subject to change without prior notice.

For matters not covered in this document, please visit our website www.kiloview.com for information and technical support.

Contents

1 PRODUCT INTRODUCTION.....	1
2 OPERATION GUIDANCE.....	2
3 PACKING LIST AND INTERFACE DESCRIPTION.....	3
3.1 PACKING LIST.....	3
3.2 INTERFACE DESCRIPTION.....	3
3.3 LED INDICATORS.....	4
4 INSTALLATION AND CONNECTION.....	5
4.1 CONNECT POWER AND VIDEO SIGNAL.....	5
4.2 CONNECT DISPLAYER.....	5
4.3 CONNECT ANALOG AUDIO.....	6
4.4 CONNECT NETWORK.....	6
5 LOGIN AND NETWORK CONFIGURATION.....	7
5.1 LOGIN TO WEB PAGE.....	7
5.2 NETWORK CONFIGURATIONS.....	8
6 FUNCTION CONFIGURATION.....	10
6.1 MEDIA (VIDEO DECODING).....	10
6.1.1 Video source.....	10
6.1.1.1 Add RTSP source.....	10
6.1.1.2 Add SRT source.....	11
6.1.1.3 Add NDI HX sources.....	13
6.1.1.4 NDI discovery server.....	14
6.1.1.5 Video source list.....	15
6.1.2 Video Source Preview.....	16
6.1.3 Video output setting.....	17
6.1.4 IP stream configuration.....	20
6.1.5 Image and OSD overlay.....	21
6.2 STREAM SERVICE.....	23
6.2.1 Add publishing points.....	23
6.2.2 Stream service status.....	23
6.2.3 Source selection.....	24
6.2.4 Add a streaming service.....	24
6.2.4.1 RTMP streaming service.....	24
6.2.4.2 SRT streaming service.....	25
6.2.4.3 RTSP streaming service.....	26
6.2.4.4 UDP streaming service.....	26
7 SYSTEM SETUP.....	28
7.1.1 User Management.....	28
7.1.2 System Time.....	28
7.1.3 Reset.....	29

7.1.4 Reboot.....	29
7.1.5 Restore.....	29
7.1.6 Firmware.....	29

1 Product introduction

MG300 media gateway is a high-performance embedded multi-functional device, which integrates functions such as protocols conversion, distribution, multi-channels video decoding and video image segmentation. It can be applied to video format conversion, protocol intercommunication, decoding and splitting display from different systems, manufacturers, types and encoding ways. It also works as the stream media server with the capability for 50 concurrent access.

Model	MG300
Network	2 *100/1000M RJ-45 adaptive Ethernet ports
Decoding output	1 *SD/HD/3G-SDI, Up to 1080P 60Hz 1 *HDMI 2.0, Up to 3840x2160@60Hz
Audio output/input	1*3.5mm line out; 1*3.5mm line in
USB	1*USB 3.0 Type-A
Access protocol	RTSP/SRT/ONVIF/RTMP/TS-UDP/HLS/NDI HX Version 2.0, customize for SIP
Output protocol	RTSP/SRT/RTMP/TS-UDP
Protocol conversion capability	9 channels 1080P conversion
Distribution capability	Multicast 50 channels RTSP streams (up to 600Mbps)
Live streaming capability	9 channels streams distribution/live streaming, 4 different targets per channel
Decoding capability	4K 30Hz: up to 4 channels simultaneously 1080P 50Hz/60Hz: up to 8 channels simultaneously 1080I 50/60Hz or 720P and below: up to 9 channels simultaneously
Video decoding	H.264/H.265
Audio decoding	AAC/G.711
Audio bitrates	AAC: 8Kbps~ 320Kbps G.711: 64Kbps
Decoding delay	<200ms (adjustable)
Output formats	SDI: 1080P60/59.94/50, 1080P30/29.97/25/24/23.98 1080I60/59.94/50, 720P60/59.94/50, 570i/50, 480i/60 HDMI: 4K 3840x2160@60/50/30/25, 1080p60/50/24/25/30, 1080i60/50, 720p60/50 Compatible with VESA standard format
Split display	1/2/3/4/5/6/7/8/9 user-defined screen split; 1 channel multi-pictures split for IP stream, up to 1080P60 H.264 encoding
Management	Web
Power supply/consumption	12V/1A, 6W
Dimension/weight	140*105*28mm/380g
Working temperature	-20°C~60°C

2 Operation guidance

- Installation and Connection of Device

Connect the power supply correctly and start the device. Connect the decoder HDMI/SDI interface to the displayer as needed.

- Network Connection and Configuration

First, connect the decoder's Ethernet port 1 to the switch or PC by using the network cable. Then, set up your PC's IP address in the subnet of 192.168.1.0/24, and login the web page through <http://192.168.1.168> (the default IP address of the Ethernet port 1 is 192.168.1.168), and the default login user name/password is admin/admin. After login, set parameters such as IP/DNS of the Ethernet port in the "Network" menu.

- Adding Video Sources

Login the web page, click "Add" on the "Media" menu, fill in the corresponding parameters (RTSP/RTMP/HLS and other video sources) according to the video source information, click confirm, and you can add a video source.

- Decoding output

The decoder has two output windows, select any output window and click the HDMI/SDI option to be green, which means that the window stream is output to the corresponding HDMI/SDI interface. Then drag the added video source to the output window and the decoder will start decoding it. If the decoding is normal, the video will be output.

3 Packing list and interface description

3.1 Packing list

Please check the parts and accessories you received are exactly.

Items	Unit	Quantity
MG300	set	1
DC12V/1A power adapter	pc	1
Quick start guide	pc	1
Certification and warranty card	pc	1

3.2 Interface description

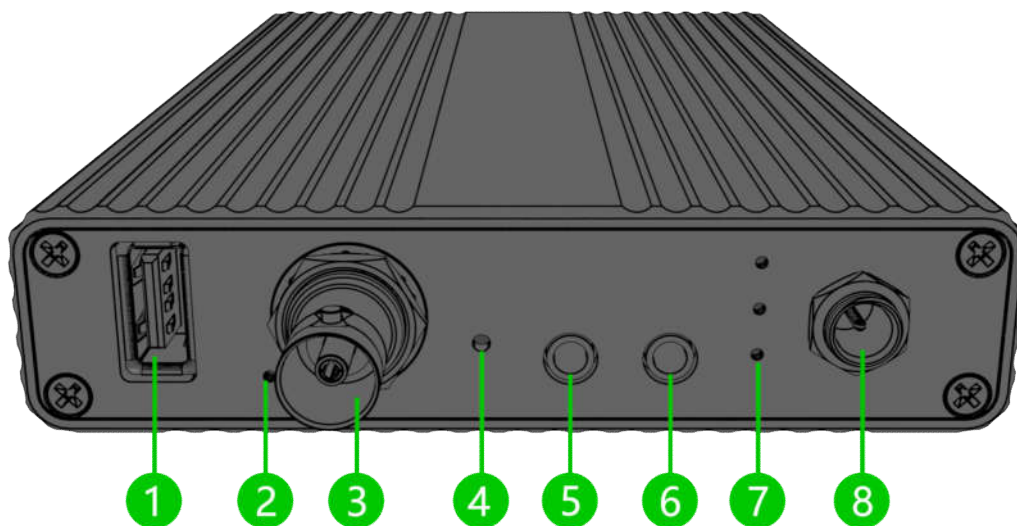



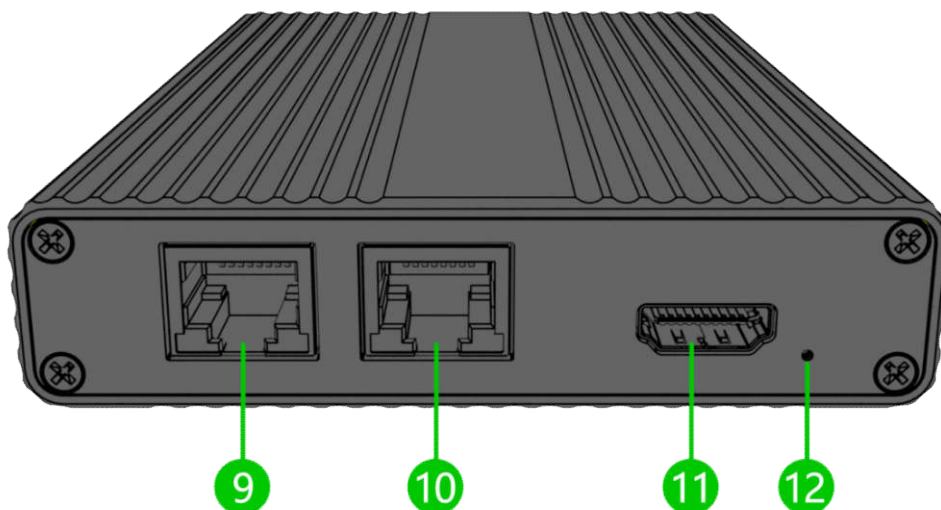

- 1.USB port 2. SDI indicator 3. SDI output 4. Reset
- 5.Audio output 6. Audio input 7. Indicator 8. Power



- 9.100/1000M Ethernet port 1 10. 100/1000M Ethernet port 2
- 11. HDMI output 12. HDMI indicator

3.3 Led indicators

Mark	Color	Status	Description
	RED	ON	Power is on
		OFF	Power is off
	GREEN	Light	Device/signal is normal
		Flash	The signal is not locked or the device is reset to factory settings (the  light will also flash)
		Off	Device/signal is abnormal
	GREEN	Light	Network is connected
		Flash	Device factory reset indication (the  light will also flash)
		Off	Network is dis-connected

4 Installation and connection

4.1 Connect power and video signal

Connect the power adaptor (DC12V/1A) to the device, the device starts working once powered on. Connect the SDI or HDMI cable to the corresponding port of the device (It can be connected at the same time, the device supports the simultaneous output of two videos), and the other end is connected to display devices such as monitor, digital signage, screens and etc.

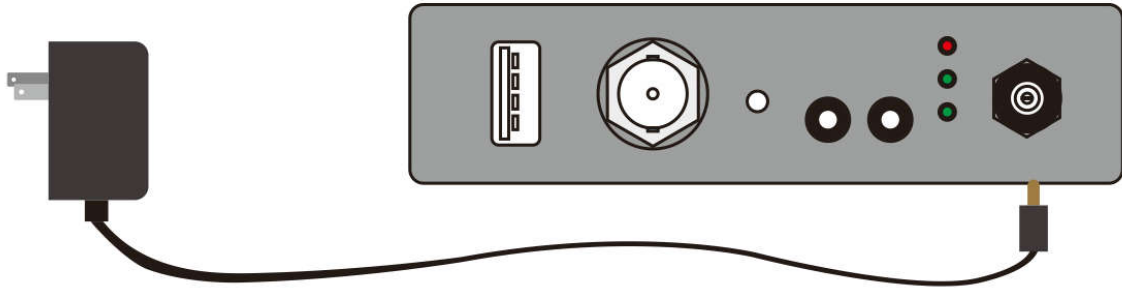

⚠ Note: Please use the standard power adaptor equipped because other unqualified power supplies may damage the device.

4.2 Connect displayer

Connect the SDI or HDMI cable to corresponding interface of the device (it can be connected at the same time, the decoder supports two signals output simultaneously), and the other end is connected to display, such as monitor or electronic screen, etc.

Using SDI cable to connect SDI output interface with SDI display.

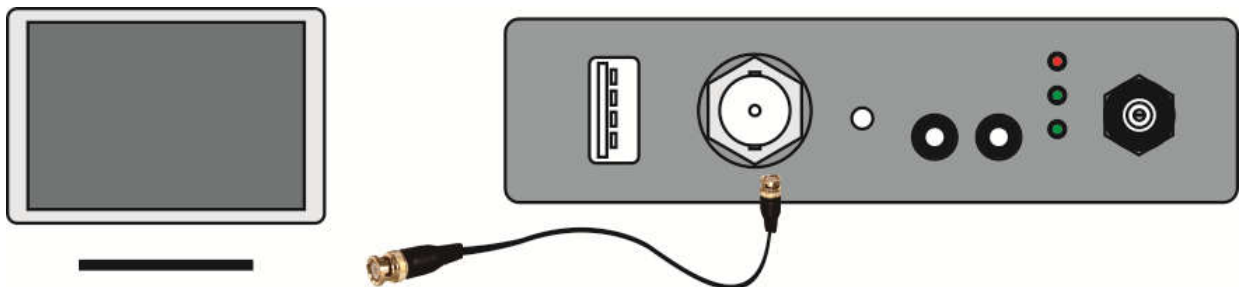

Using HDMI cable to connect HDMI output interface with HDMI display.

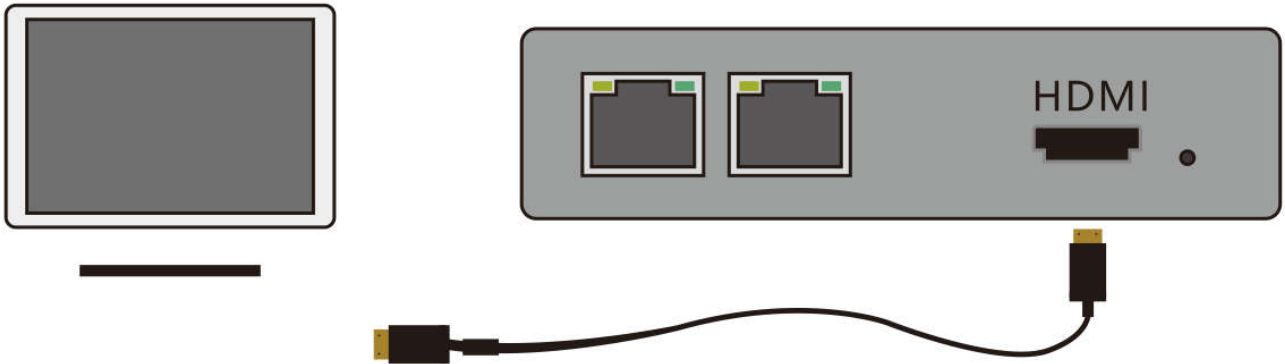

4.3 Connect analog audio

If analog audio input and output are required, the analog audio interface needs to be connected; if not, no connection is required.

4.4 Connect network

Connect one end of the cable to the decoder NET 1, the other end is connected to the network switch or the computer's Ethernet port. Both NET 1 and NET 2 are workable, normally using NET 1.

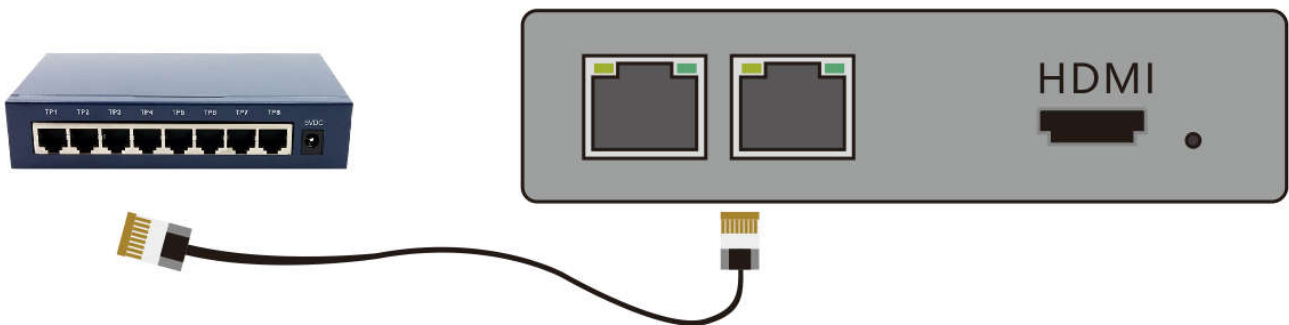

⚠ Note: There are two Ethernet ports that you can connect to different networks. Normally, it can work by connecting to Ethernet port 1.

5 Login and network configuration

5.1 Login to Web page

First, you need to set the decoder and the computer to be on the same network segment so that the computer can login to the decoder's web page. The default IP of decoder network port 1 is 192.168.1.168. If the computer IP is not 192.168.1.* network segment, it is necessary to set the computer network port IP to 192.168.1.* network segment.

After setting up the IP address of the computer, open the web browser, directly fill in the IP address of the device (Default is 192.168.1.168) or the URL `http://192.168.1.168` and click enter to open the login interface. When you open the page, a dialog box for authentication will pop up, and you need to fill in the user name and password, select the language of the menu. The default user name and password of the decoder is “admin/admin”, and then click "login".

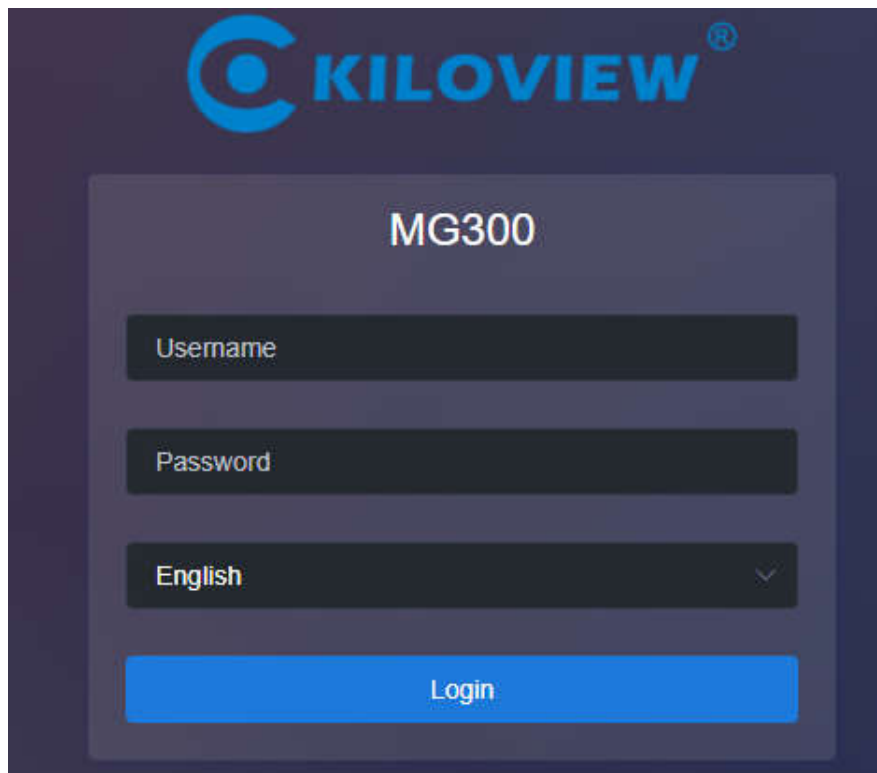

 **Note:** Due to the browser compatibility issues, it may cause the web page display abnormal, it is recommended to use Chrome or Firefox browser.

After login, you can set decoding and other parameters on the Web page. The left window is for preview, the right is Output 1 and 2. You can close the preview window, Webpage as blow:

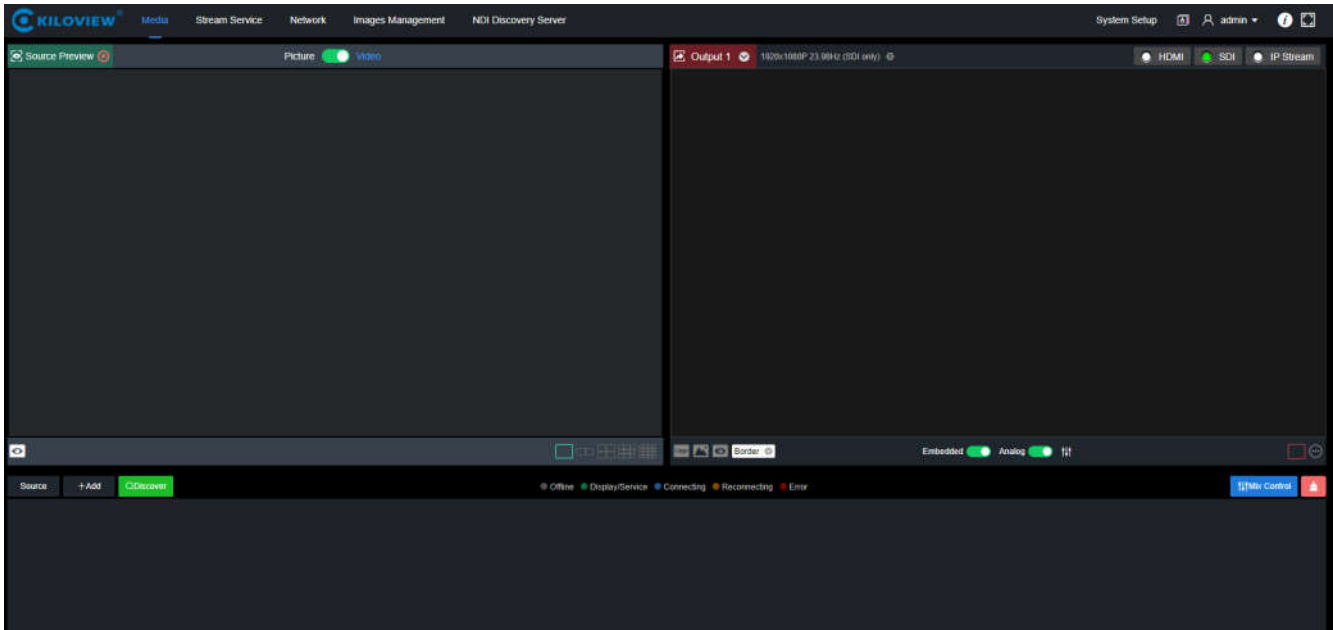

5.2 Network configurations

The decoder has two Ethernet ports. Generally, it only needs to configure the address 1 of network 1. This IP is used for network streaming and device management. The two ports are used as service separation between LAN and Internet or data flow separation between service and management.

Click "Network" to enter the configuration page. The network interface icon is shown as green to indicate the normal working state of network, and the network interface icon is shown as orange to indicate the disconnected state of network.

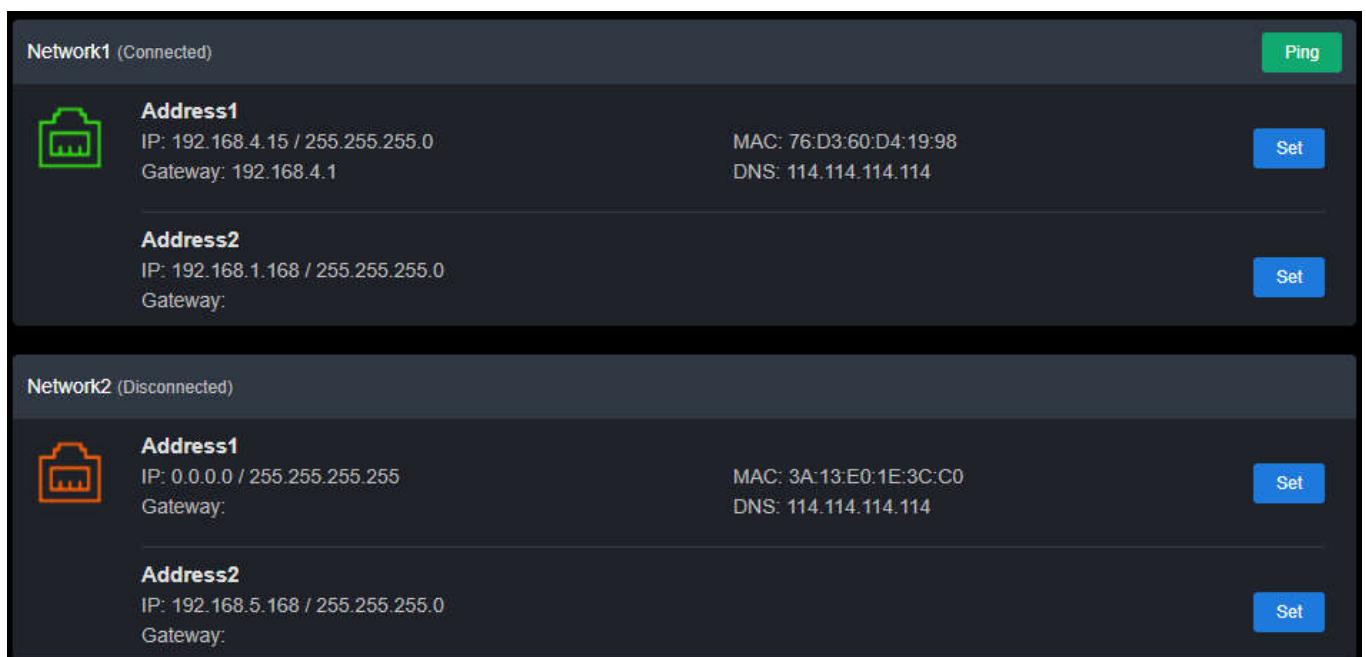

Each network port can be configured with 2 IP addresses: "Address 1" is configured to be the working IP of the device; "Address 2" is used as the default management address and device management as well.

Click the "Set" of "Network 1- Address 1" to configure the IP address. You can get your IP address by "DHCP Dynamic" and "Manual Set". The IP address obtained by DHCP may change, while the IP address specified manually is fixed for the convenience of device management. IP address configuration is according to the actual situation of your local network configuration.

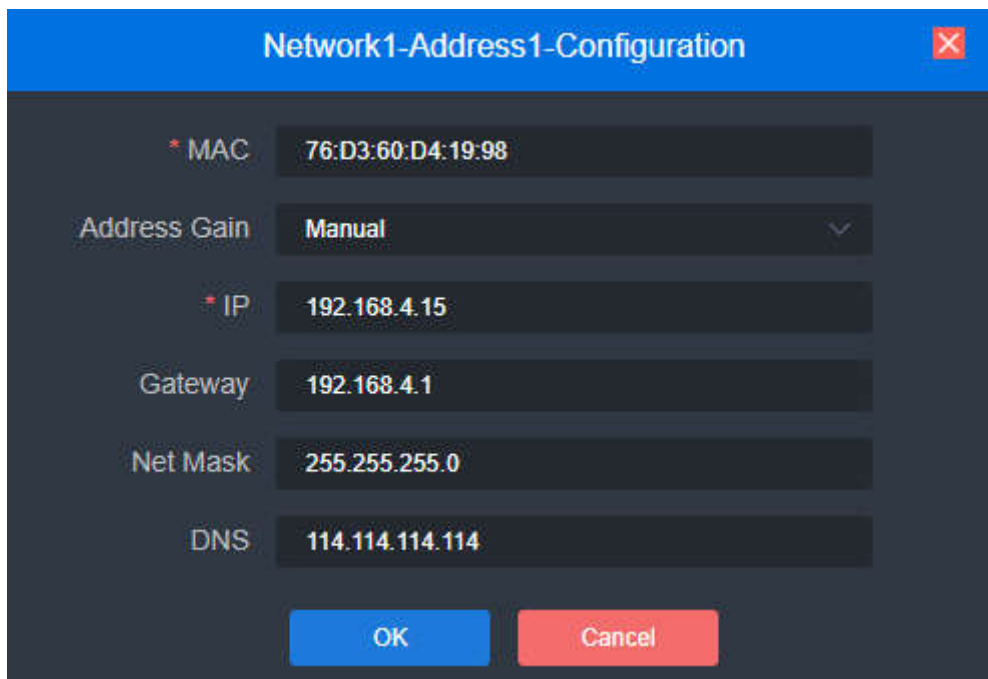

To choose manual configuration, you need to set the IP, Gateway, Mask, DNS parameters in turn. If the local network is in 192.168.4. */24 subnet, you can configure Address 1 to 192.168.4.15, 255.255.255.0, 192.168.4.1, and 8.8.8.8.

After the IP address is configured, you can test whether the IP address can ping through other computers in the local network, or access the web page of the device through <http://192.168.4.15>. Only when the IP address configuration is correct can the device work properly.

The configuration of network port 2 can be set as instructed for network port 1.

⚠ NOTE: *Because the device saves the configuration file to the system regularly, the device cannot power off immediately after the IP address is manually configured or modified, otherwise the IP address may be lost. If you want to save the configuration immediately, you can restart the device once on the web page.*

6 Function Configuration

6.1 Media (Video decoding)

Click the "Media" to configure the decoding parameters. There are three main functions: one is to add video sources and source list; the second is to preview, the third is to display output information such as streaming, split-screen, layout and etc.

6.1.1 Video source

6.1.1.1 Add RTSP source

Click "Add", then configure the parameters in the pop-up dialog, and click "OK" to add a video source. Two URL addresses can be added under the same "Name", one main stream and one sub-stream. The main stream is for decoding output. The sub stream is for preview. If only filled main stream address, both preview and output will adopt main stream.

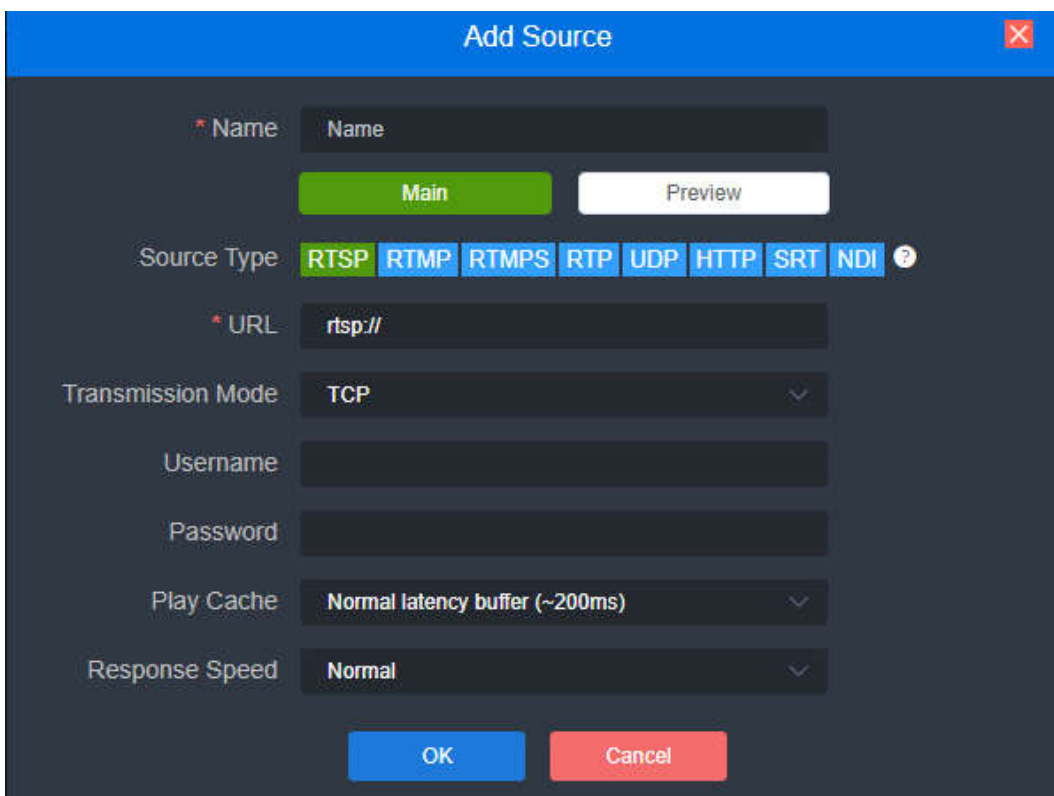

⚠ NOTE: Please make sure to get the correct URL address of the video source from live platforms. The abnormal working source address will cause the device not to work properly. (Video source can be testified by VLC player.)

The above image shows how to add video source through RTSP stream, for other streams, please check below tables for reference.

The parameters of the video source are defined as follows:

Name	Video source name
URL Address	Support RTSP, RTMP, RTMPS, UDP, HTTP and other protocols, decoder can automatically identify the URL address. After entering the URL address, if some advanced parameters are configured, the dialog box will auto pop up for your configuration. You can also click on the protocol options on the page to set the parameters directly.
Transmission Mode	Choose TCP or UDP. TCP is reliable transmission and UDP is unreliable transmission
User/Password	Normally, no configuration is required. It depends whether or not the video source is authenticated by the user.
Decoding buffer and latency	Various buffer strategies for choice, including zero buffer, 50ms, 120ms, 200ms, 500ms, 1s. It counts on your actual network conditions, good network set with lower latency, and bad network with higher latency.
Video Receiving Port	Network receiving port 1-65535
Audio Receiving Port	Network receiving port 1-65535
Binding Network	Auto by default
Video Coder	Format is [PT,]CODER[/Timestamp-unit],i.e.96,H264/90000
Audio Coder	Format is [PT,] CODER [/Timestamp-unit/channels],i.e.96,MPEG4-GENERIC/48000/2

6.1.1.2 Add SRT source

1) Add an SRT source on WEB page by "Media"-"Add Source"-"SRT".

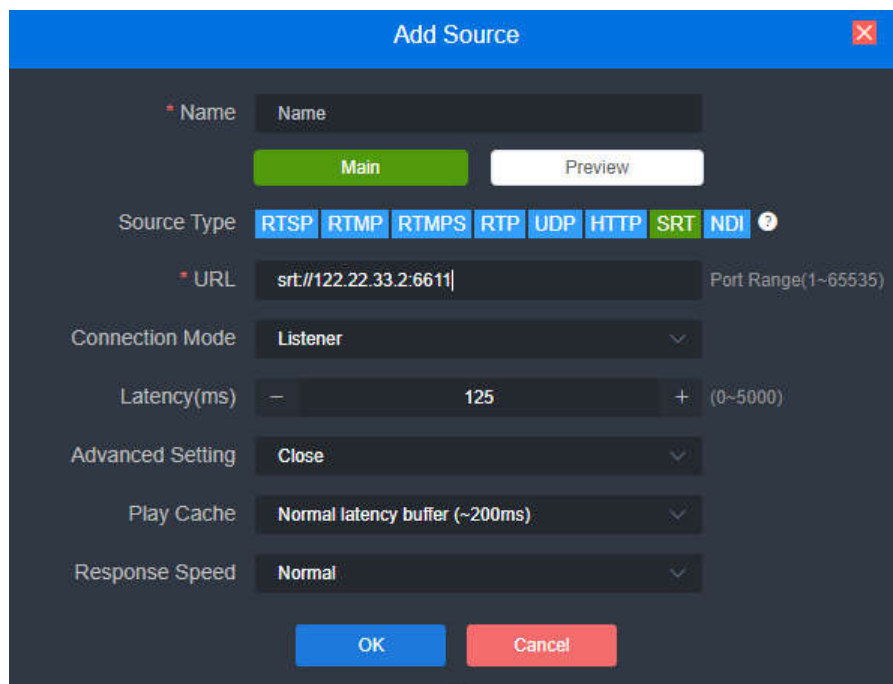

SRT source parameters description as below:

Name: You can name it freely, letters and numbers combination;

Connection Mode: Caller, Listener, Rendezvous;

URL address: When using the CALLER mode, the URL address is: srt:// the peer public IP address: port;

when using the LISTENER mode, the URL address is: srt://:port

Address: Set IP address of the receiving port;

Port: Configure a listening port which should be consistent with the sending port;

Latency: It depends on the performance of your current network. The Latency can be set at both ends of the SRT source and the SRT target device, and the larger of the two values will be selected as the SRT transmission delay;

Encryption Mode: AES-128, AES-192 and AES-256;

Key: encryption key, fill in 10-32 letters or numbers according to the encryption method;

Bandwidth Overhead: Percentage value that configured according to your network conditions. Multiply this percentage value by the total video and audio bitrate encoded by the encoder to get the maximum bandwidth occupied by the overhead allowed by Bandwidth Overhead. The sum of this value and the video and audio bitrate is the current SRT transmission bandwidth threshold, which is also the maximum bandwidth available for SRT streams. From the perspective of "overhead", it is the extra "invalid" bandwidth to be used in addition to the media content required for transmission (it can be understood as a payload), but it is different from those common protocol overlay, TCP header overhead or UDP header overhead. The bandwidth overhead here is not a fixed 20~60 bytes TCP header overhead or 8 bytes UDP header overhead, but changes in real time according to the network conditions. The worse the network link conditions, the more the required transmission. The setting range is 5%~100%, and the default size is 25%;

Payload size: The sending data packet size. The receiver should match the same size of the data packet sent. The default size is 1316, which is the optimal packet size for encoding and decoding.

2) Please drag the added SRT source to the output window, and the decoder starts to listen for SRT requests, it will establish the SRT connection while receiving the right SRT "Call". After connected, the status will show "Pull".

6.1.1.3 Add NDI|HX sources

1) Add NDI|HX video sources automatically

Click “Discover” on “Media” tab, you will discover NDI sources in the same network segment in the pop-up dialog. According to the device name and channel name of your NDI source, select and “Add” the source you want to decode, the video source will be added to the video source list.

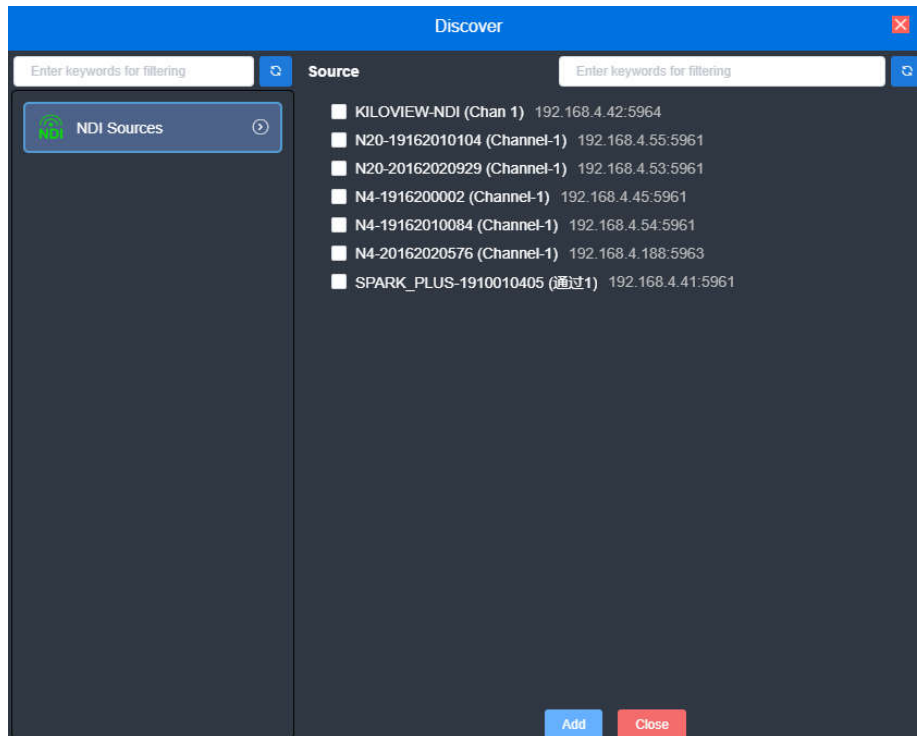

2) Manually add NDI|HX sources from non-public group or cross-segment IP

Click “Set” of “NDI Sources” and go for source configuration. If you want to search for devices with different group names in the same subnet, filling in the specified group name in “Group” box, then click the “Enter” button. At this time, two group names will be displayed in the "Group" box, and then click "OK", the device will start to search for all NDI sources under these two group names at the same time (You are allowed to add multiple group names to search).

When you need to search for NDI sources across network segments, and the group name is a non-public group, you need to fill in the specified group name firstly, and then fill in the specified IP address in the "IP" box, click , the IP address will be added to the "Manual Scan Address List". You can add multiple IP addresses to search at the same time, and then press "OK".

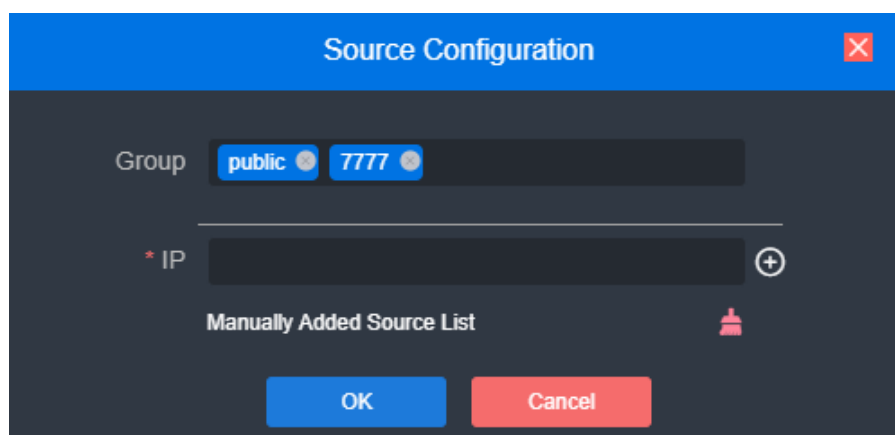

3) Add NDI|HX source by filling in the URL address

Click “Add” of “Media” tab, select "NDI", and fill in the corresponding parameters;

Name: English and numbers combinations;

URL address: ndi://source IP address: port (Default port is 5961);

NDI name: Device name of the source (channel name);

Stream: Full (main stream) and Preview (sub stream) optional;

Play cache: Select the play cache according to your actual scene.

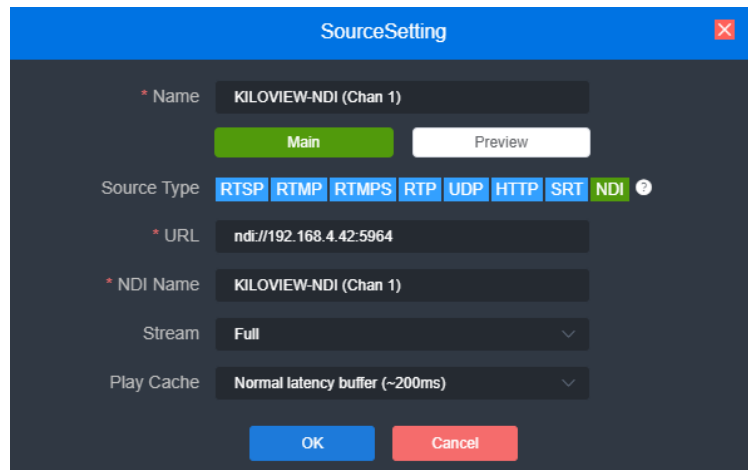

⚠ NOTE : *MG300 only decodes NDI|HX version 2.0 video source. For FULL NDI source, please choose other NDI products such as N3/N30/N4/N40*

6.1.1.4 NDI discovery server

The NDI discovery server function is a discovery mechanism that is different from the NDI automatic discovery function. It supports NDI centralized registration discovery and cross-network segment discovery. After the specified NDI source and receiver are registered to the NDI discovery server, this part of the NDI source will only appear in the list of registered receivers (not in the list of all receivers), and NDI sources across network segments will also be discovered and connected by the receiving end.

Please download and install the NDI|HX driver from the NewTek official website (<https://www.newtek.com/ndi/tools/#>). NDI tool on Windows system, then execute Bin\Utilities\x64\NDI Discovery Service.exe.



The NDI encoder configures the IP address of the computer where the discovery server is located in the discovery server, and NDI will register to the server. It is recommended that the server address is configured as a static IP address to prevent the loss of NDI connection due to IP reassignment.

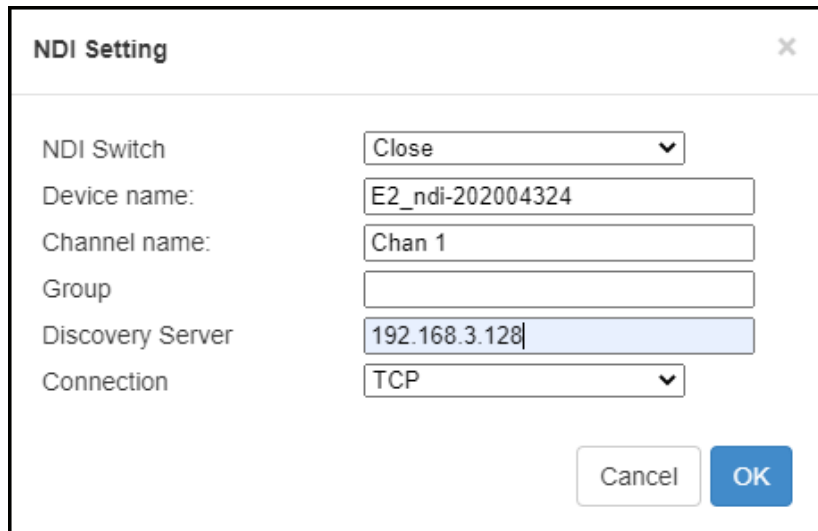

Open the NDI discovery server, and fill in the IP address of the computer where the server located, and the device will search for the NDI stream that has been registered to the discovery server (Please refer to chapter 6.1.1.3 to decoding).

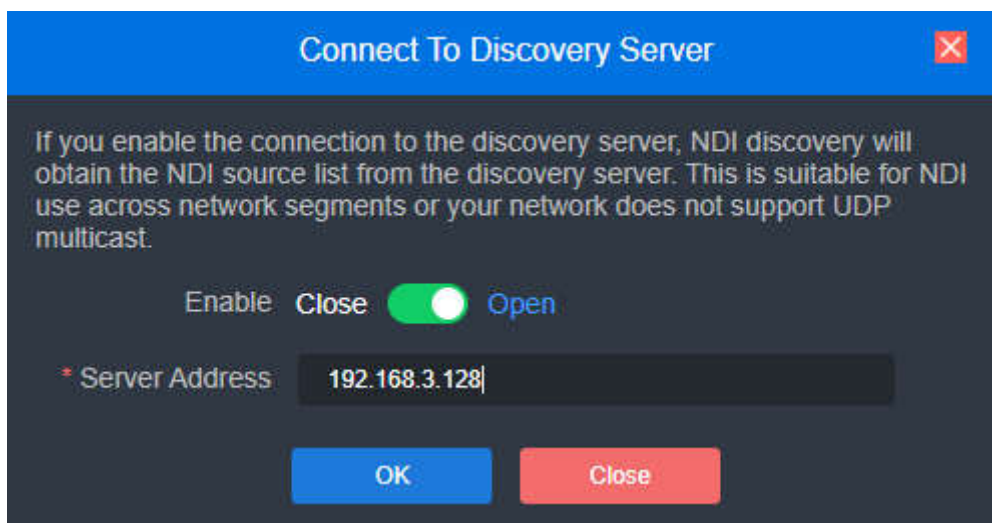

6.1.1.5 Video source list

This list shows all the video sources and source parameter information you added, not all of them are decoded. If decoding to output or for preview, you need to manually drag it to the upper preview or output window for decoding. When the video source is shown as green "Display/Service", the source is decoding or streaming; the gray "Offline" means it is not used as decoding source; the blue "Connecting" indicates that the source is establishing a connection and is ready to decode; and the Yellow "Reconnecting" indicates that the source is decoding abnormally and tries to connect and decode. The Red "wrong" indicates the source is wrong and can not be decoded.



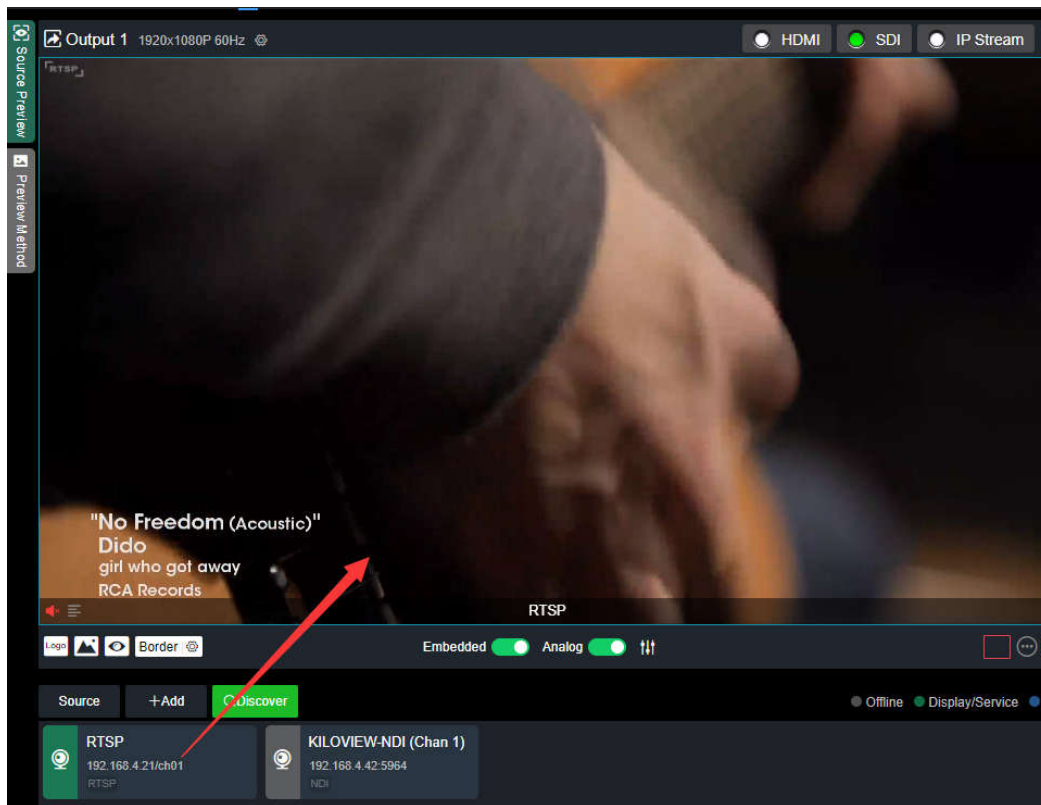

⚠ NOTE : *It is non-decoding status, after video sources being added. You need to drag it into the above output window, then the device starts to connect to the source and decode it.*

6.1.2 Video Source Preview

Support preview of video source on WEB page, and can be closed on the upper left corner. Picture/video switch button can switch picture or video preview mode.

- Support picture/video preview. If you use pictures in the preview, you will see the picture stream, which is expressed as a picture change in about three seconds; when you use the video preview, it is a smooth video;
- The preview function mainly consumes the computer's CPU/GPU performance. If the multi-screen preview is freezing, it may be related to your computer performance;
- Preview supports 1/2/4/9/16 split screen, up to 16 split screen previews;
- Required browser: the latest version of Google and Edge;
- Only support for local preview in the same LAN for the computer and device, and cannot preview across WAN;
- Display of decoding status and source parameter information.

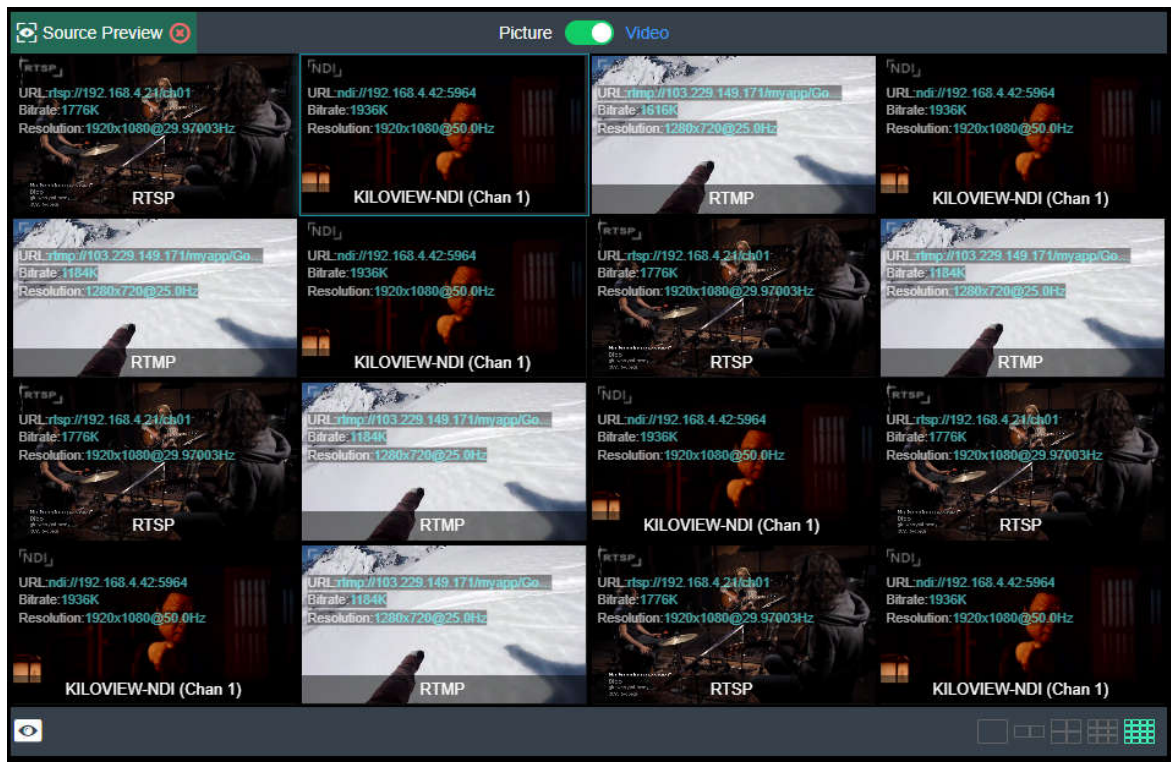

⚠ NOTE: The browser preview does not support video sources with B-frame encoding and H.265 encoding.

6.1.3 Video output setting

The decoder supports H.265/H.264 decoding and simultaneously output of the same and different sources or split screens.

Take "Output 1" as an example for detailed description on the output window (shown as below):

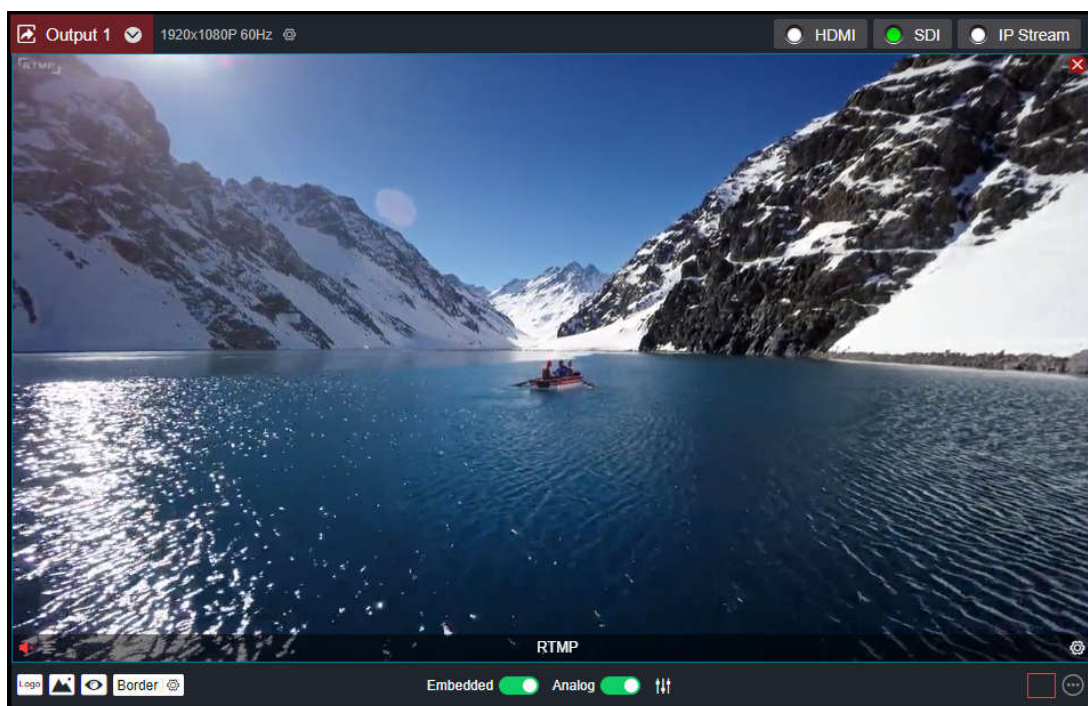

- ① Click the gear button to set video output parameters

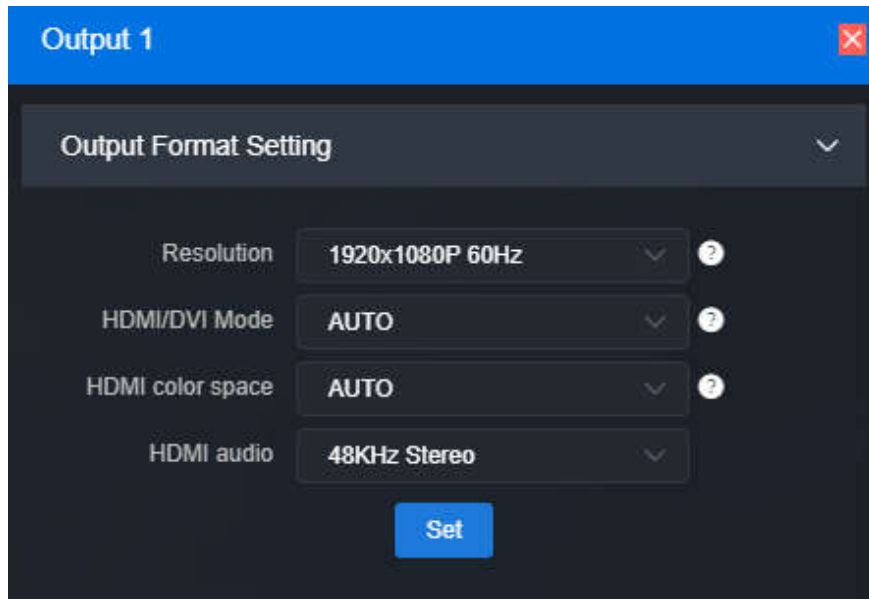

HDMI/DVI Mode:

Three modes can be selected: automatic mode, HDMI mode and DVI mode. If "Automation" is selected, the HDMI/DVI mode will be automatically selected according to the EDID description of the device connected. In DVI mode, the color space and audio parameters cannot be set.

HDMI color space:

You can select "Automation", "RGB444", "YCBCR444", "YCBCR422", "YCBCR420". If "Automation" is selected, an appropriate color space will be automatically selected according to the EDID description of the HDMI device connected. If it cannot output in this case, please choose the right HDMI color space by yourself.

HDMI audio:

32K/44.1K/48KHz dual channel can be selected. Please choose what you need according to your actual needs, the default is 48KHz.

- ② Display current video source information

It can display the current output of video source resolution format, URL, current bit rate and other parameters.

- ③ Setting up the way of video output

There are 3 output modes: HDMI/SDI/IP stream. If select HDMI, it means the current source will be output to HDMI interface; If SDI, the current source will be output to SDI interface; If IP stream, support single-picture or multi-picture splitting for re-encoding and output through IP stream.



HDMI/SDI can only be selected by one signal output window at the same time. If Output 1 was originally selected as HDMI, and then click output 2 to select HDMI, HDMI selection box of output 1 will become gray and signal output will be closed. When a signal output window selects both HDMI and SDI, it represents that the current screen will be output to both HDMI and SDI interfaces.

Two output windows can choose the same signal source and screen splitting, or can be set to different signal sources and screen splitting.

④ Audio on/off

Click  to enable and disable the output audio

⑤ icon switch

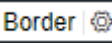
Click  to turn on/off the display of overlay LOGO; click  to turn on and off the display of the background overlay; click  to turn on and off the source status and information display; click  to turn on and off the frame overlay, and click “settings” to set the frame color.

⑥ Audio gain setting

You can set the gain of "embedded" and "analog" audio of HDMI/SDI.

⑦ Screen splitting settings

The decoder can display 4 split screen modes by default, and optional layout of 1/2/3/4/5/6/7/8/9 split screens. By clicking the extension button on the right, you can set the split screen mode, 1-4 options. In the extended button, the selected split screen mode is bright, and the unselected is gray, and up to 4 split screen modes can be selected.

Click "Add Layout" to enter the layout editing page. Select the split screen layout, you can drag the size and overlay picture-in-picture of the multi-screen in the layout at will, and the layout can also be modified in real time while it is in use.

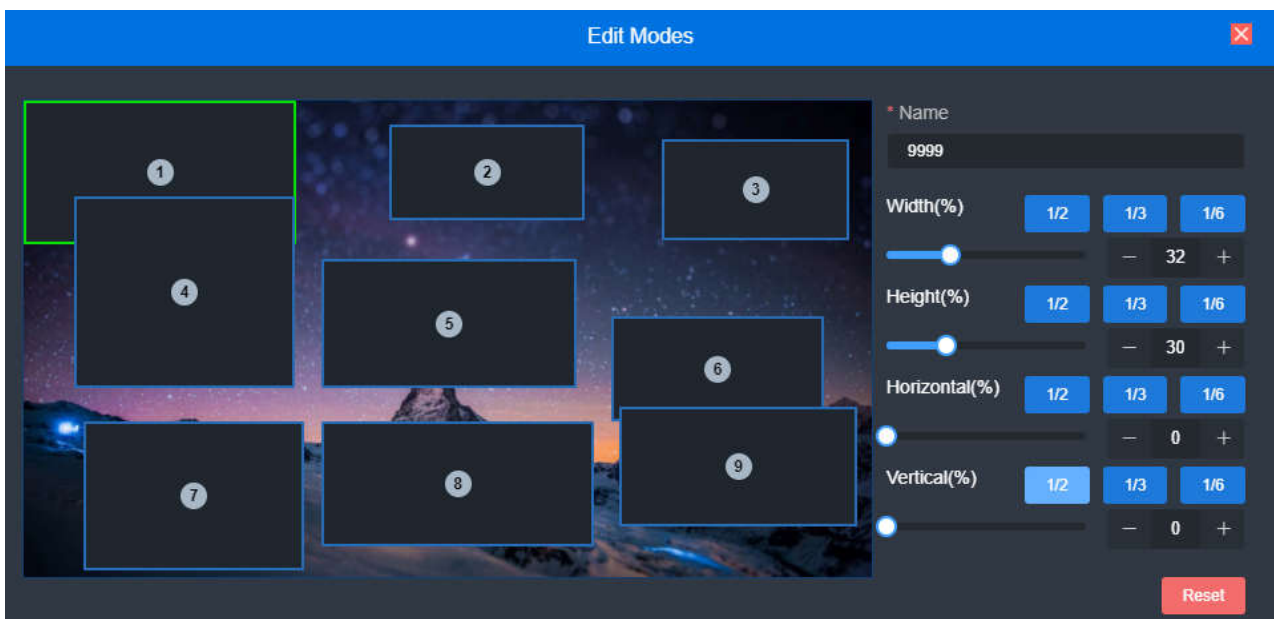

⑧ Video Source Settings

Click "SET" to modify the parameters of the video source directly, Click the“X” to delete the video source; click "ⓘ" to pop up the video source parameters and decoding status information.



6.1.4 IP stream configuration

Select "IP Stream" to re-encode and output IP stream of the single or multi-split screen. Click "Set" for main stream and sub stream configurations.



When configuring the encoding parameters, you can output the re-encoded stream with a different protocol when the stream (refer to section 6.2 for configuration) is outputting. In the stream service, you can see output 1, which is to re-encode and output the video source from the Output 1 window. It is divided into main stream and sub stream encoding.

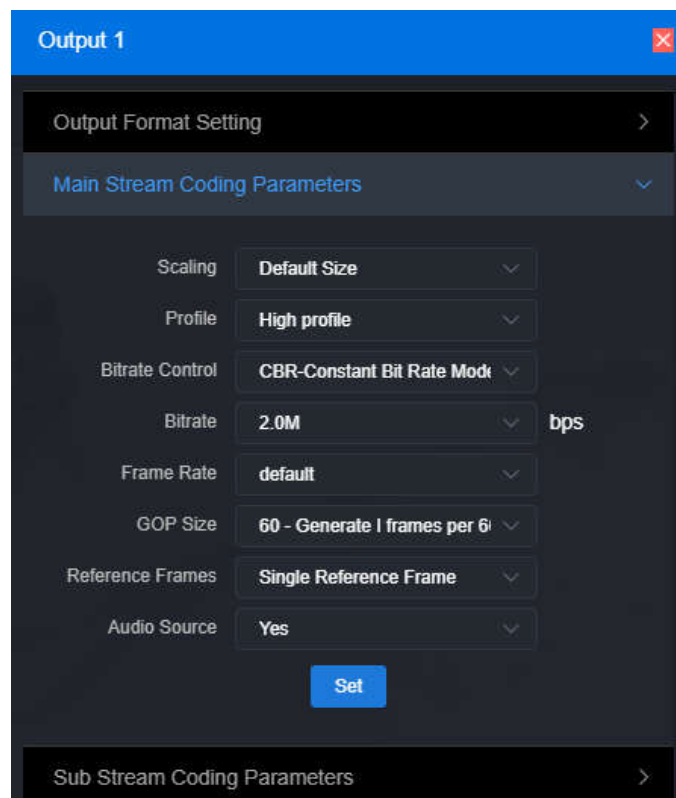

"Scaling" has 9 options, the default setting is the decoding output setting resolution.

"Profile" supports three grades, High profile, main profile, baseline, and three grades. It is set according to the encoding grade supported by the platform. High profile has the highest compression efficiency. At the same bitrate, the image quality is the best. Baseline is the most widely supported. The default setting is High profile.

There are two "rate control methods", CBR-constant bit rate mode and VBR-dynamic bit rate mode. According to the literal meaning, CBR is a stable bit rate, and VBR is a constantly changing bit rate based on the actual content. Generally, network transmission use CBR to ensure transmission quality, and use VBR for file storage to ensure video file quality. The default setting is CBR-constant bit rate mode. "Encoding rate" supports adjustment between 64K-25M. The higher the bit rate, the better the encoded video quality. The specific settings should be based on your actual network situation. It should be not higher than the upstream bandwidth of your network.

"Frame rate" has three options: full frame rate, automatic halving when the original video frame rate ≥ 50 , and custom. Full frame rate means how many frames input, and how many frames will be output; When the original video frame rate ≥ 50 , it will automatically be halved, which means that when the incoming video is 1920*1080P50, then the encoded video will have a frame rate of 25 frames, which will save the consumption of network bandwidth. Custom is to manually specify the frame rate of the video after encoding, in principle, it cannot be higher than the original frame rate of the video.

"GOP size (frame interval)" has 5 options and supports custom adjustment. This is adjusted according to the actual situation. The default is 60. This value can also meet most needs.

"Reference frame" has two options: single reference frame and multiple reference frame. Generally, using multiple reference frames can improve the encoding quality, but some encoders and players may not support multiple reference frames.

For the sub-stream parameter settings, please refer to the configuration of the main stream.

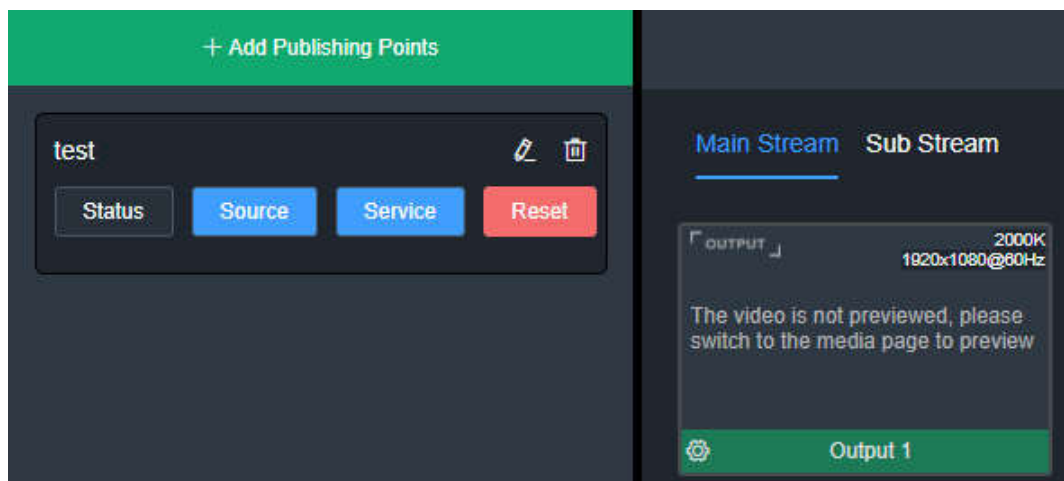

6.1.5 Image and OSD overlay

Image overlay is divided into logo and background overlay. First, you need to upload the image in the image management, and then go to the overlay settings for overlay settings.

1) Picture management

On the page "Picture Management"- "Add Picture", in the pop-up box, fill in the name and choose Logo/Background for the type, then select a picture to upload.

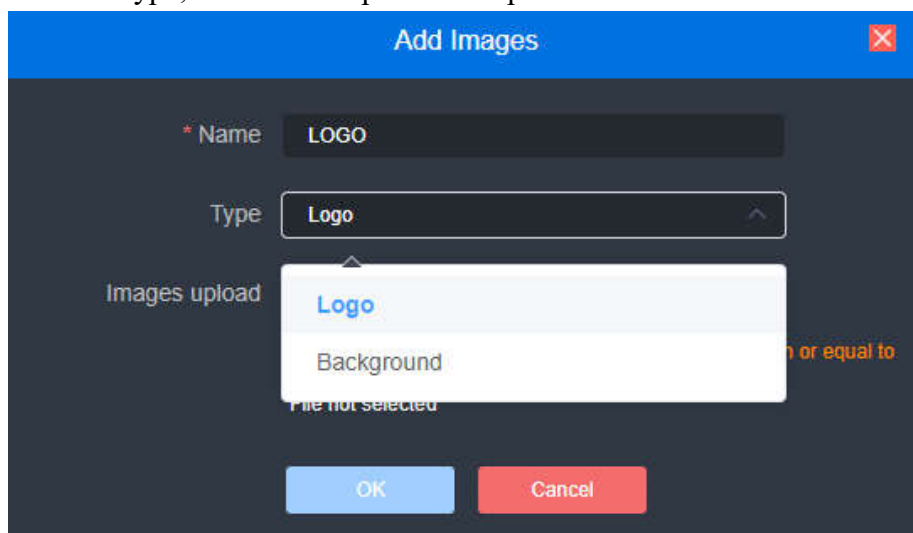

Click the output (1/2) box setting and select your picture or logo. You can overlay your Logo either place on the Window. After clicking "Set" to save, you can see the overlaid effect on the output screen.

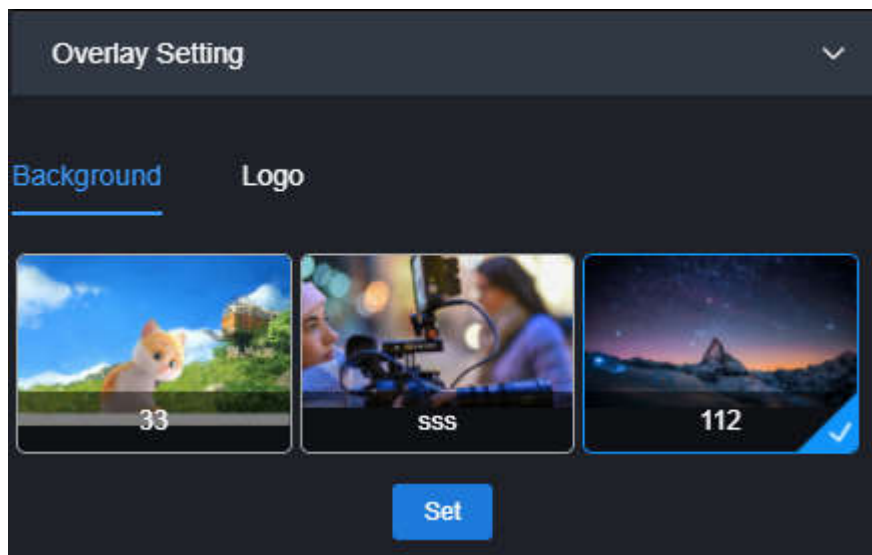

2) OSD overlay

First, you can have an overall configuration for the overlay and adjust the overlay position. It allows you to adjust the character's position in the display according to the actual situation.

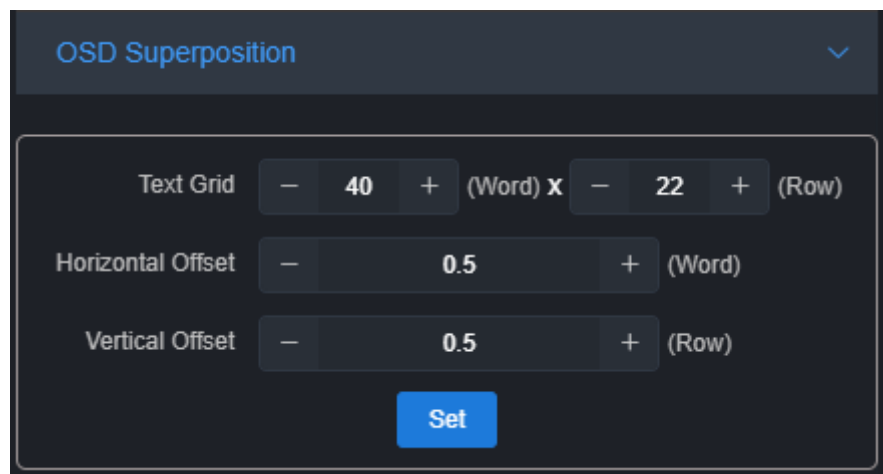

- Screen grid: Divide the screen into horizontal M grids and vertical N lines, each character occupies one grid;
- Horizontal shift: Adjust character position in the horizontal direction of the screen. The unit is character.
- Vertical shift: Adjust character position in the vertical direction of the screen. The unit is character.

Then set the overlay parameters, select "Overlay Type", and configure the overlay function separately for the "Text" and "System Time" and "the overlay items".

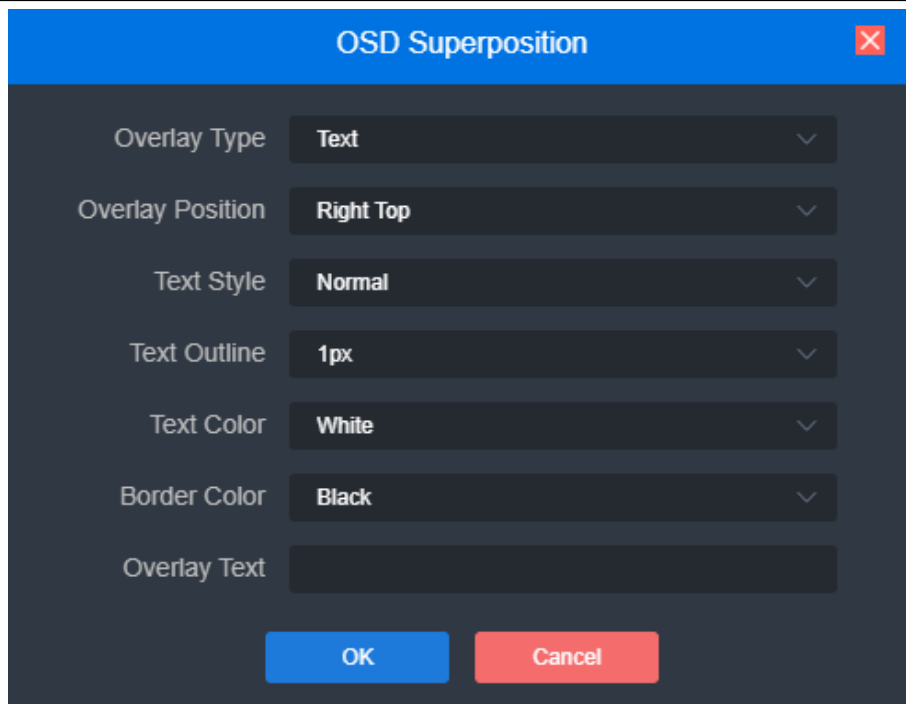

- Overlay type: "No superimposition, text, date, time and date/time" can be selected;
- Overlay position: 7 preset display positions and custom positions can be selected, and the display position of characters after overlay can be selected according to actual needs;
- Horizontal position: when the overlay position is customized, adjust the character shift based on the global horizontal shift setting;
- Vertical position: When the overlay position is customized, adjust the character shift based on the global vertical shift setting;
- Text style: normal and bold;
- Text outline: 0-10px;
- Text color: optional;
- Border color: optional

6.2 Stream service

MG300 supports for the most common protocols conversion. The sources can be dynamically switched. If the input video stream is RTSP, RTMP, UDP, SRT and other protocols, you can convert them to the same or different protocol streams. The output streaming protocols are RTSP, RTMP, SRT and TS-UDP.

6.2.1 Add publishing points

In "Stream service" menu, click "Add Publishing Points"- "Name", enter name to add publishing point. You can add nine publishing points for each source, and each one publishing point can stream to four destinations.

6.2.2 Stream service status

- The number of streams: Display the number of streaming services you added;
- The current bitrate: Display the status of the bitrate;
- Total traffic: The total traffic of the current service output;
- Current source: Name of your selected output source

6.2.3 Source selection

When there are multiple sources in the list, you can select the video source that needs to be output, at which point the output screen automatically switches.

6.2.4 Add a streaming service

6.2.4.1 RTMP streaming service

- 1) Add a new publishing point or configuration at an existing publishing point, "add streaming service" - "service type" - "RTMP" service;
- 2) Fill in the push address provided by the live platforms.

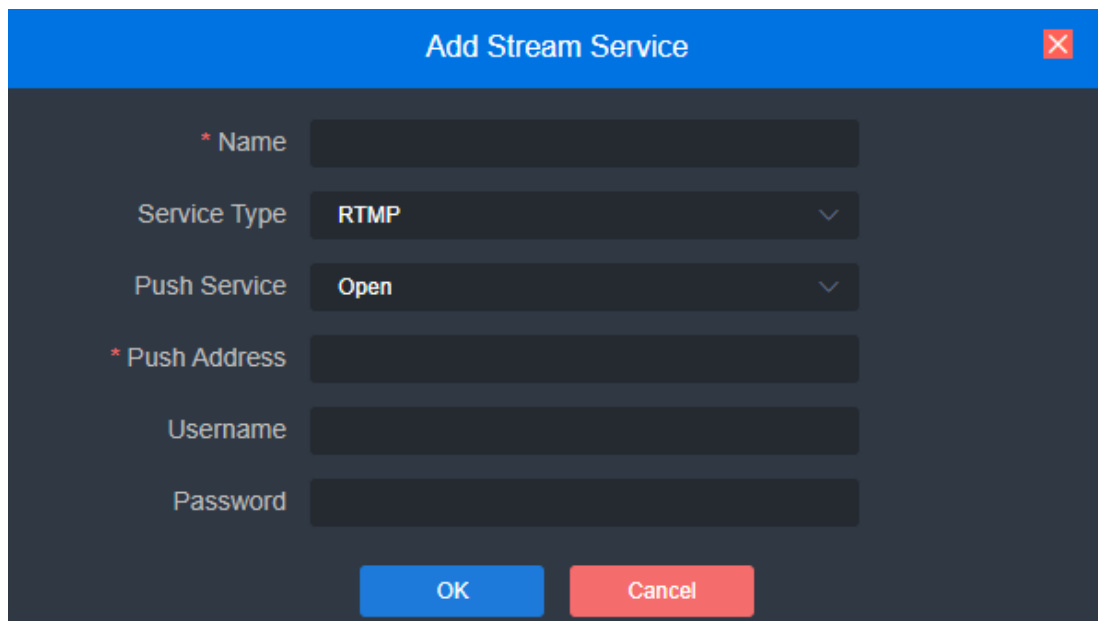

- Enable the push service: you can enable or disable the streaming service;
- Push Address: Fill in the RTMP push address provided by the live platform, e.g. <rtmp://113.249.149.171/live/test>;
- Username/password: Set according to RTMP streaming service platform needs.

Once the configuration is complete, the RTMP streaming service appears as follows:

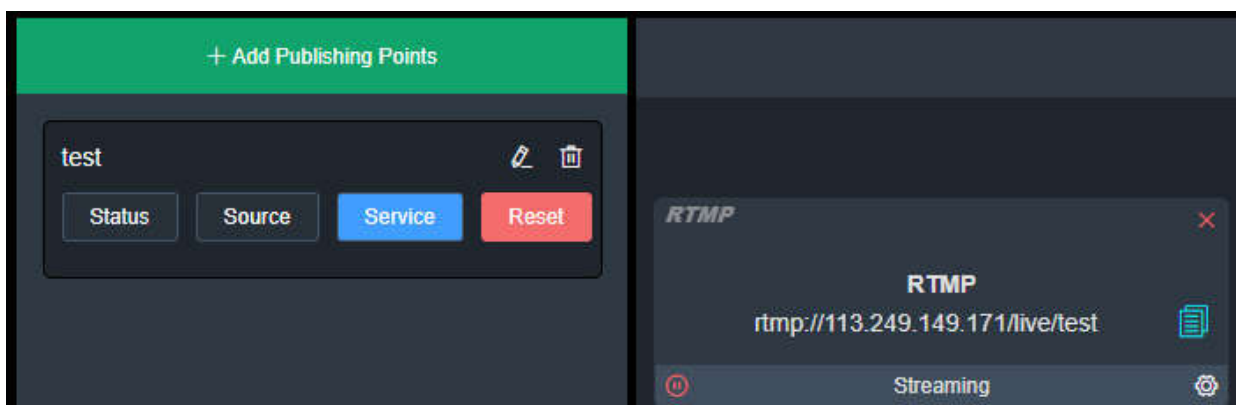

In the source selection, select the stream that needs to be converted. For example, you can convert the selected stream to RTMP streaming.

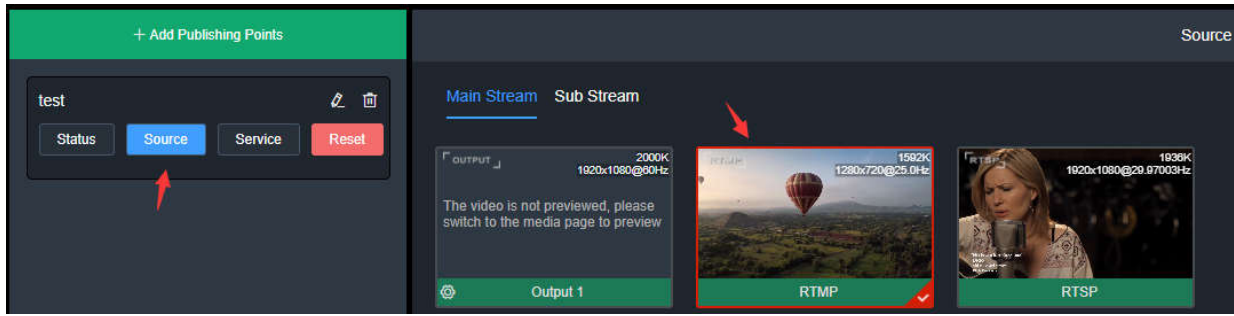

6.2.4.2 SRT streaming service

- 1) In the publishing point you have created, add a streaming service and select the service type as SRT. Fill in the corresponding configuration parameters (reference to section 6.1.1.2)

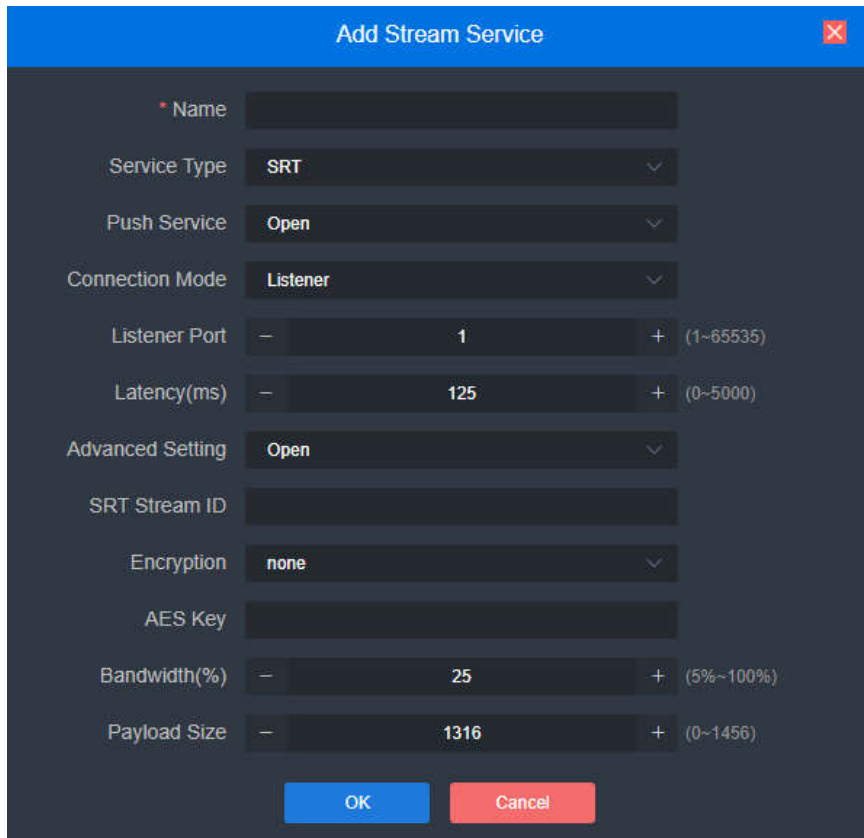

- 2) Once the configuration is complete, you can switch between different source transformations in the source selection, and the SRT streaming service appears as follows:

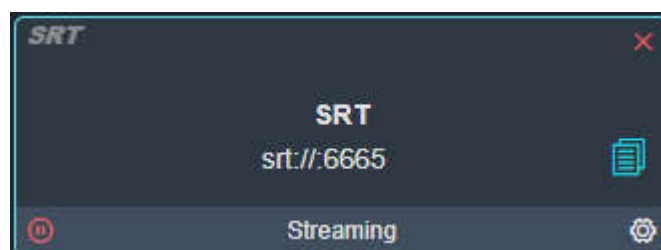

6.2.4.3 RTSP streaming service

To add a new publishing point or configure it at an existing publishing point, click "Add Streaming Service" - "Service Type" - "RTSP" service.

- Session ID: Fill in the RTSP service session ID, you can enter letters and numbers or combinations;
- Service port: RTSP default service port is 554, which can be modified according to actual needs.

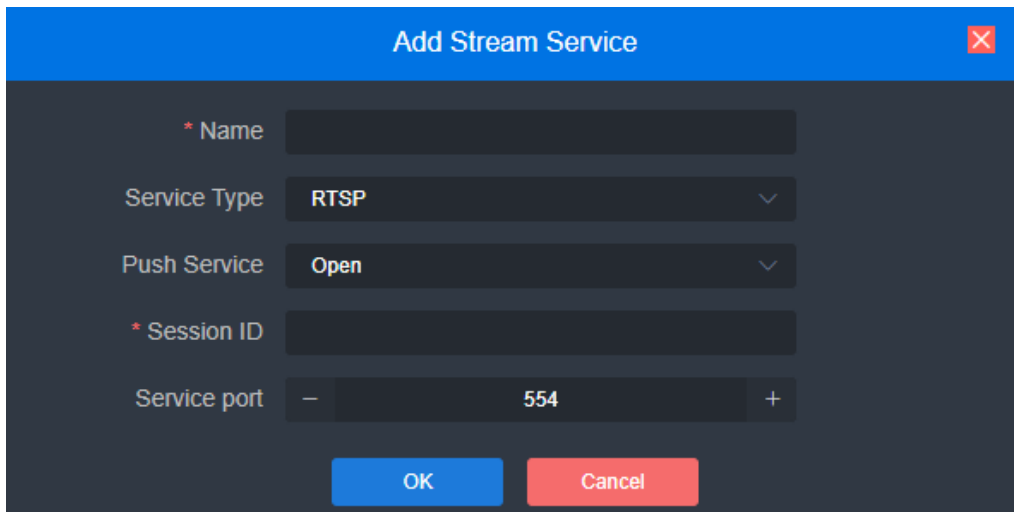

Once the configuration is complete, different source transformations can be switched in the source selection, as shown in the RTSP streaming service as follows:

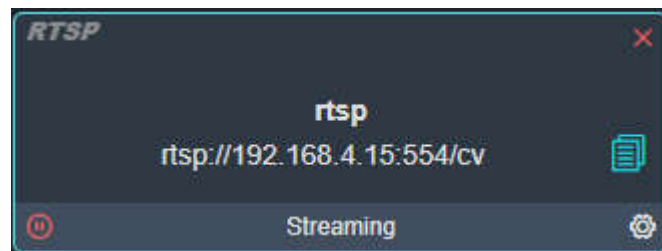

6.2.4.4 UDP streaming service

To add a new publishing point or configure it at an existing publishing point, click "Add Streaming Service" - "Service Type" - "UDP-TS" service.

TS-UDP streaming is divided into unicast and multicast. If you use unicast, "push destination address" is the IP address of the receiving device, "target port" is either port, it is better not to conflict with the ports of other services. "Multicast TTL" does not need to be modified. If using multicast, please fill in the correct pushing address (224.x.x.x to 239.x.x.x), and the Destination Port is any port you want, make sure it will not conflict with the ports of other services.

TS Advanced Options parameters for advanced users, require the background of research and development for TS stream. If there are no special requirements, it is recommended to use the default.

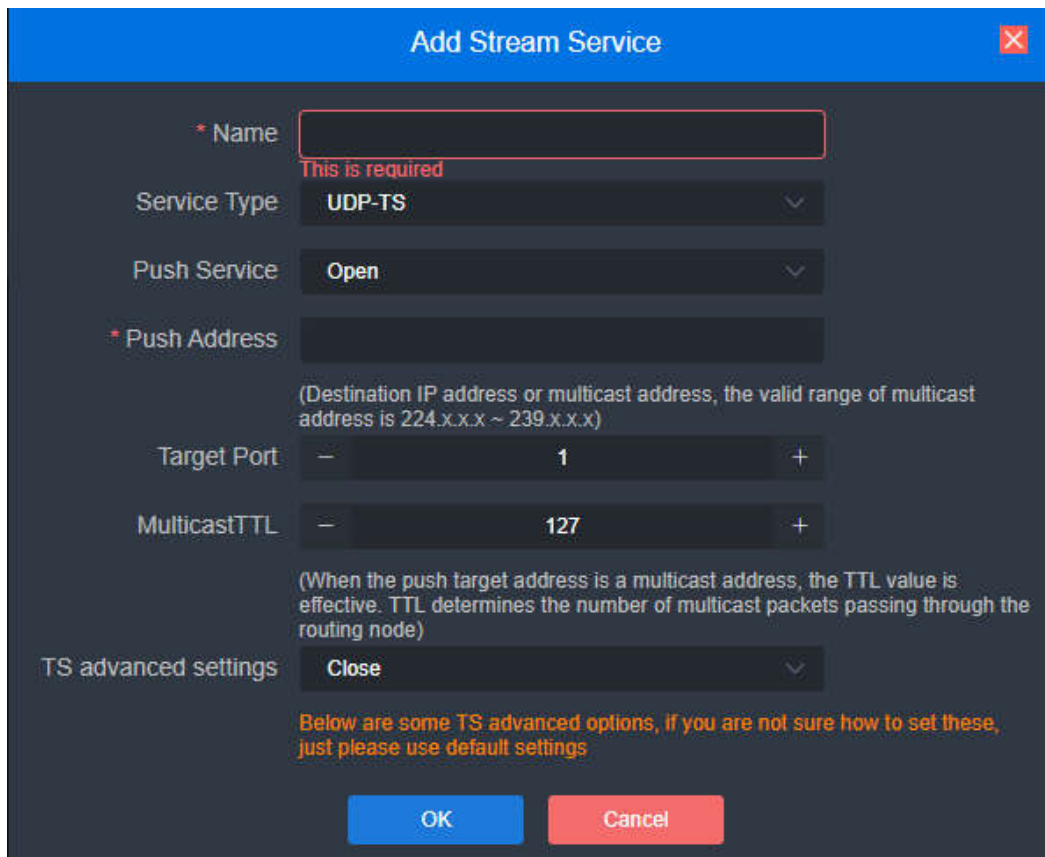

Once the configuration is complete, you can switch between different source conversions in the source selection, and the UDP streaming service appears as follows:



⚠️ Note: When you configure the broadcast streaming method to get the URL is `udp://225.6.6.6:1234`, if you play with VLC Player, you need to insert a symbol `@` in the URL to play properly, i.e. `udp://@225.6.6.6:1234`.

7 System setup

7.1.1 User Management

Viewing User Lists, Adding and Deleting Users

Batch Deletion		+ Add User		User list	
<input type="checkbox"/>	User name	Alias	Create time	Operation	
<input type="checkbox"/>	admin	Admin	1970-01-01 00:00:00		
<input type="checkbox"/>	xclab	xclab	1970-01-01 10:33:11		
			Total 2		1
				10/page	

7.1.2 System Time

Timing mode can be set: synchronization with current PC, manual timing and slave NTP server. Select the right time zone to ensure the correct time from the NTP server.

Choose your location and region



Current device time

Mode

Time

7.1.3 Reset

It is used to reset decoding services, usually used to make the modified parameters take effect immediately or decode abnormal situations. The current decoding services will be temporarily interrupted, requiring about 3S.

7.1.4 Reboot

Device software restart, it lasts about 3 minutes.

7.1.5 Restore

If users change parameters that lead decoder can't work (The typical situation is changed network address, so it can't login decoder), users could restore factory setting to default value.

There are two ways to restore the factory settings. Restoring the factory settings will lead to a hard restart of the device. The restart process will take about 3 minutes.

- 1) WEB page "Restore", click to take effect.
- 2) RESET button of device panel. At the RESET button position of the device, hold down the reset key and keep for more than 5 seconds. The device will be restored to the factory settings.

Below parameters will be restored after restoring factory setting:

- Login username and password will be turned to admin;
- The IP address of Ethernet port 1 will be restored to 192.168.1.168/24, and the IP address of Ethernet port 2 will be restored to 1.168.2.168/24;
- All the video/audio decoding settings will be restored;
- Streaming settings will be restored.

7.1.6 Firmware

Please check the device information and firmware before upgrading, download the firmware to the local computer in advance. Click "Select File", and then click "Upgrade", and the device will start upgrading.

After the firmware is uploaded successfully, the power cannot be cut off during the upgrade process. After the upgrade, the device will restart. The whole upgrade process will last about 3-5 minutes (depending on the size of firmware and network environment).

After the device is restarted, you can click on the upper right button to see if the software version is consistent with the planned upgrade.

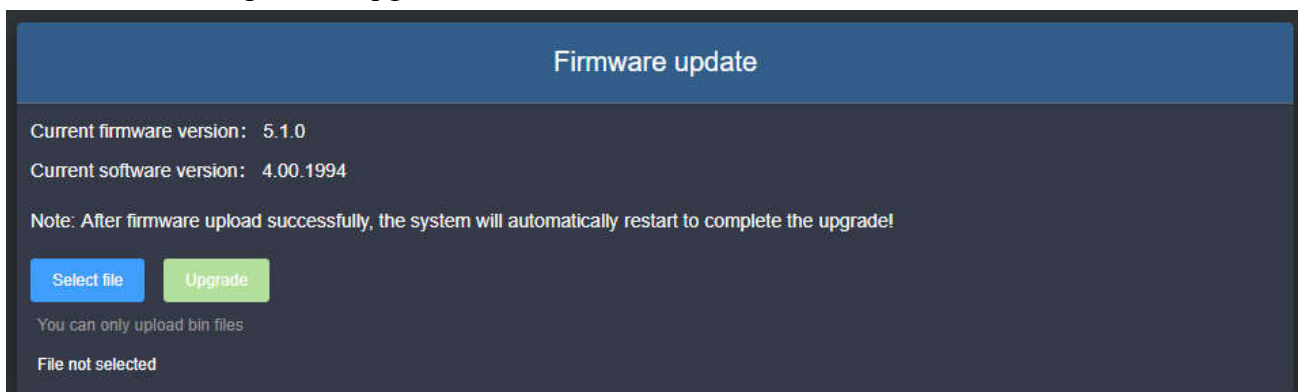

Thank you for reading

Changsha KILOVIEW Electronics CO., LTD.

Service Hotline: 86-731-88315979

Website: en.kiloview.com

Technical support Email: support@kiloview.com

Skype: support_72698/keqiu wang

WhatsApp: +86-18573195156/18573195256

Address: 188#, Middle Huanbao Rd, Yuhua District, Changsha, Hunan Province, China